

Key Features and Benefits

- ▶ Plug + Play
- ▶ Ultra low noise
- ▶ Negligible temperature drift
- ▶ Available with EtherCAT, RS422 and USB
- ▶ Up to 1000 Hz sampling rate
- ▶ Dustproof and water resistant
- ▶ Compatible with ROS, LabVIEW and MATLAB



Technical Specifications

Please refer to the table for all sensor specifications. For additional information about the sensor, we recommend speaking with one of our engineers by contacting info@botasys.com.

LaxONE Force/Torque Sensor

	F_x, F_y	F_z	M_x, M_y	M_z
Range	1800 N	4000 N	60 Nm	60 Nm
Overload	7200 N	12800 N	160 Nm	200 Nm
Noise Free Resolution*	0.7 N	0.5 N	0.02 Nm	0.007 Nm
Size (D x L)	83 mm x 44.5 mm			
Ingress Protection	Dustproof and water-resistant			
Operating Temperature	0° – 55° C			
	Serial		EtherCAT	
Communication	USB, RS422		CANopen over EtherCAT	
Maximum Sampling Rate	800 Hz		1000 Hz	
IMU	--		6 DoF IMU	
Acceleration	--		±2g, 4g, 8g, 16g	
Gyroscope	--		±250°/sec, ±500°/sec, ±1000°/sec, ±2000°/sec	
Power Supply	5 V, 1.0 W		9 – 70 V, 1.5 W	
Weight	~472 grams		~479 grams	

* We define noise-free resolution as the peak-to-peak noise (6σ) of a signal with no load in a stable environment. The signal's samples are obtained at a frequency of 100 Hz.

Mechanical Dimensions

Side Connector Configuration

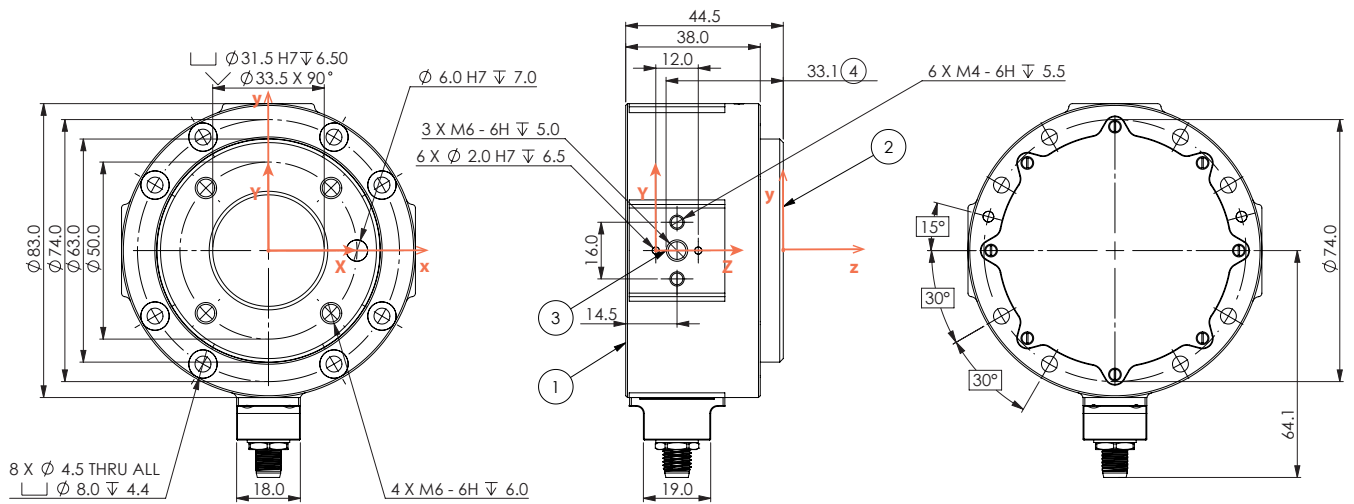

LaxONE by Bota Systems AG

1. Robot mounting side
2. Tool mounting side
3. 6 DoF IMU location
4. Distance between IMU and force/torque sensor coordinate systems

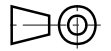

Connector Pinout

Serial

IP67 M8 Connector Pinout

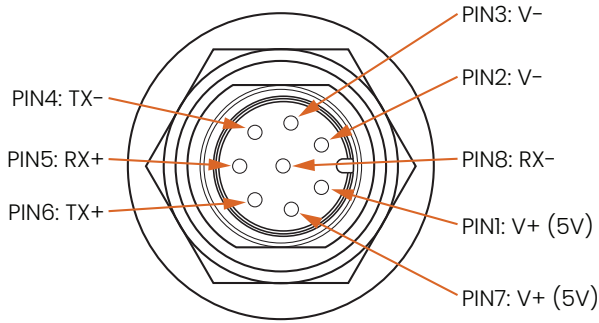

EtherCAT

IP67 M8 Connector Pinout

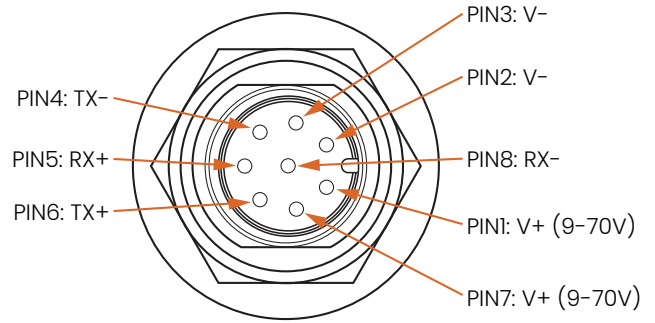

Combined Loading Graphs

During single-axis loading, the sensor can operate up to its normal range. Above the sensor's normal range, the readings become inaccurate. The sensor should not work outside of its normal operating range.

When more than one axis is loaded, it becomes a combined loading, and the range of the sensor reduces.

The following graphs represent the combined loading scenarios, and the **orange area** represents the sensor's normal operating range.

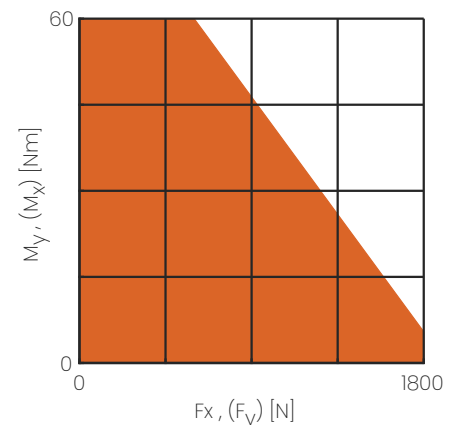
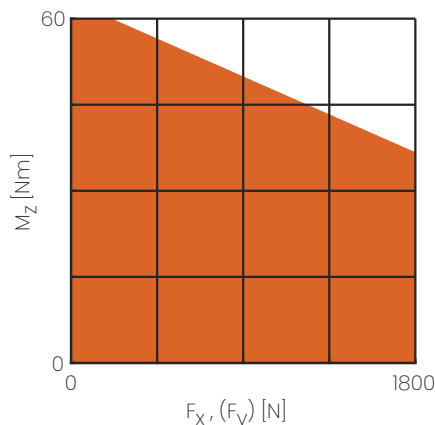
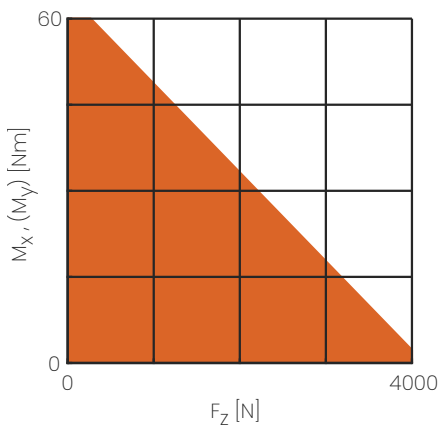

For more information, please refer to the [user manual](#).