







# DATASHEET

2FG14

v1.0

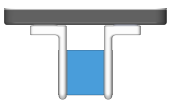
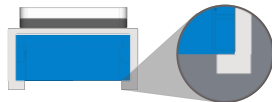
# 1. Datasheet

## 1.1. 2FG14

General Properties		Minimum	Typical	Maximum	Unit	
Payload force fit 		- -	- -	14 30.8	[kg] [lb]	
Payload form fit 		- -	- -	20 44.09	[kg] [lb]	
Total stroke		-	50 1.96	-	[mm] [inch]	
Grip width range	External	Fingers inwards 	5 0.196	-	55 2.16	[mm] [inch]
		Fingers outwards 	55 2.16	-	105 4.13	[mm] [inch]
	Internal	Fingers inwards 	17.6 0.69	-	67.6 2.66	[mm] [inch]
		Fingers outwards 	67.6 2.66	-	117.6 4.62	[mm] [inch]
Gripping repeatability		- -	+/- 0.1 +/- 0.004	- -	[mm] [inch]	
Gripping force *		40	-	280	[N]	
Gripping force tolerance		-	-	+/-10	[N]	
Allowed torque on finger platform**	Around X	-	-	30	[Nm]	
	Around Y	-	-	25	[Nm]	
Gripping speed ***		16	-	450	[mm/s]	
Gripping time (including brake activation) ****		-	200	-	[ms]	
Hold workpiece if power loss?		Yes				
Storage temperature		0	-	60	[°C]	
		32	-	140	[°F]	
Motor		Integrated, electric BLDC				
IP Classification		IP67				
Gear grease: NSF H1 approved; meets FDA regulation 21 CFR 178.3570 for incidental food contact applications						

General Properties	Minimum	Typical	Maximum	Unit
Dimensions [L x W x D]	155.2 x 115 x 70 6.11 x 4.53 x 2.76			[mm] [inch]
Weight	1.5 3.3			[kg] [lb]

\* The required current is 2000 mA, less current will result in less gripping force. See the [Force vs Current Graph](#).

\*\* See [Maximum Allowed Torque](#) for more details.

\*\*\* Relatively from the gripping object (both arms).

\*\*\*\* At 4 mm stroke and 80 N. The typical value is 300 ms at 80 mm and 150 N.

Operating Conditions	Minimum	Typical	Maximum	Unit
Power supply	20	24	25	[V]
Current consumption	-	-	2000 *	[mA]
Operation temperature	0 32	- -	50 122	[°C] [°F]
Relative humidity (non-condensing)	0	-	95	[%]
Calculated operation life	30 000	-	-	[Hours]

\* Automatically adapts to the current requirements. For more information, see the [Current Requirements](#) section.

### Force vs Current Graph

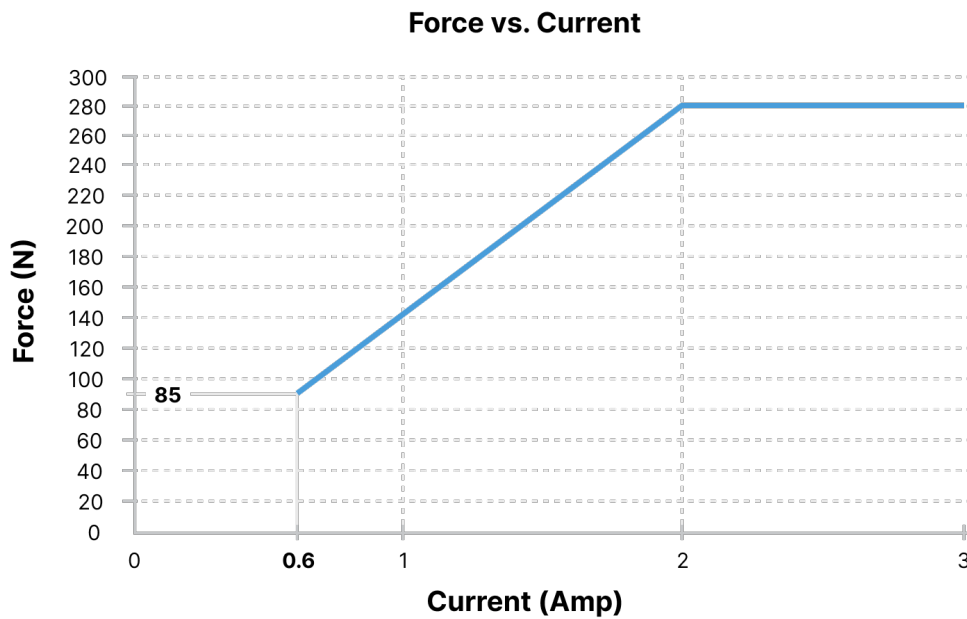

## Force Sensor

The gripper has a force sensor in the finger on the connector side as shown in the figure below.

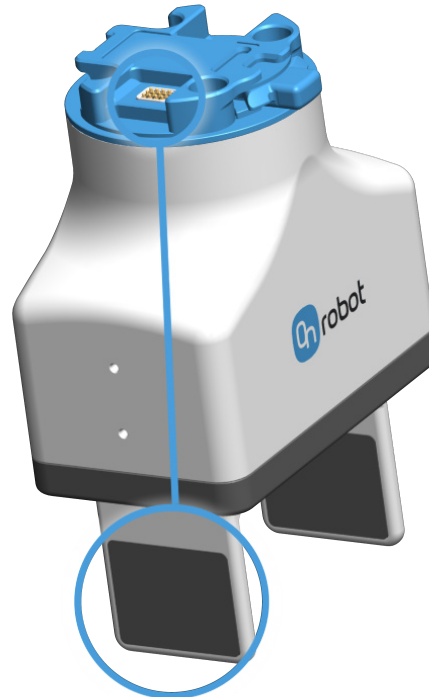

Consider the presence of the force sensor when the workpiece is aligned by using the fingers of the gripper or when the workpiece is picked sideways since the gravity can affect the force measurement.

In the latter case, orient the gripper so the finger with the sensor is on top. Make sure that the bottom finger touches the workpiece slightly before the top finger touches it, as shown in the figure below.

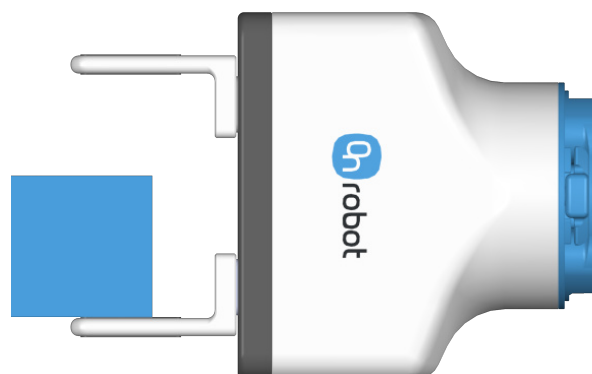

## Fingers

The supplied fingers can be mounted in two different positions to achieve different gripping ranges.

	Inwards	Outwards
External grip range [mm]	5-55	55-105
Internal grip range [mm]	17,6-67,6	67,6-117,6

The delivered finger length is 12.50 mm (L in the drawing below). If custom fingers are required, they can be made to fit the gripper according to the dimensions (mm)[inch] shown below. Use M4x8mm screws and 1 Nm torque to attach the fingers.

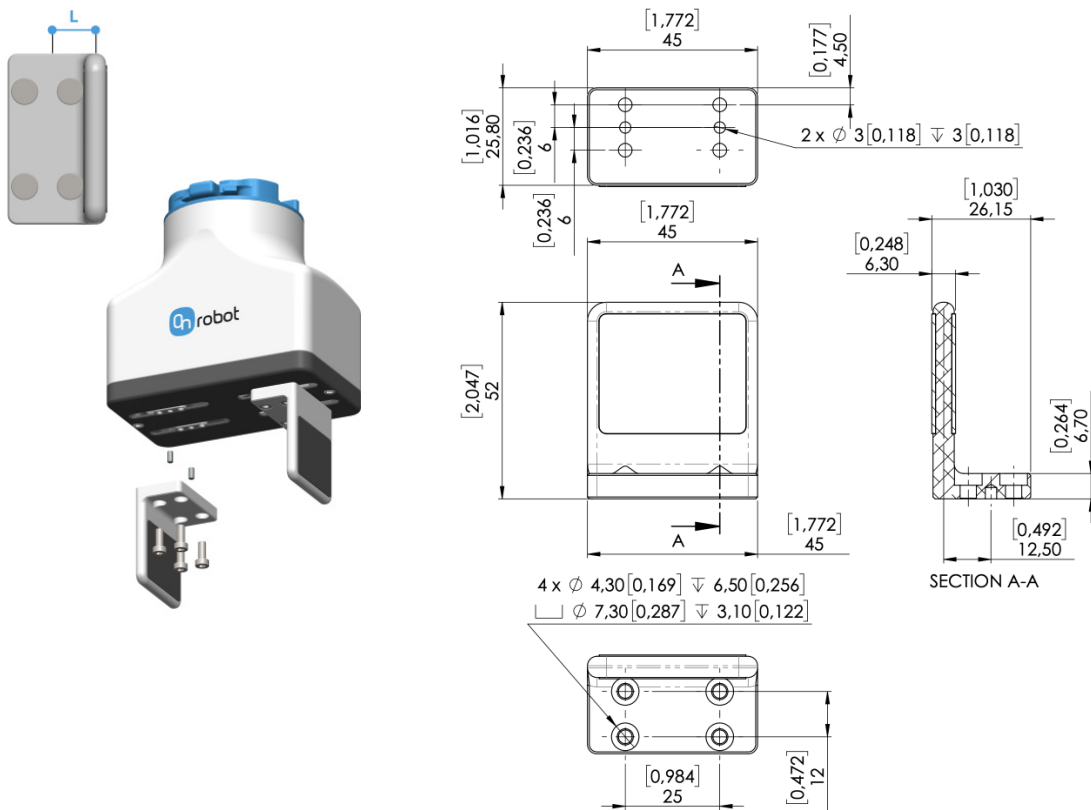

### Maximum Allowed Torque

The maximum allowed torque applied to the gripper finger platforms around X is 30 Nm and around Y is 25Nm. The picture below shows the coordinate system from where the maximum allowed torque is calculated.

The torque around Y results from gripping force and workpiece accelerations, while the torque around X results only from workpiece accelerations.

25 Nm corresponds to full gripping force at 90 mm from finger platform.

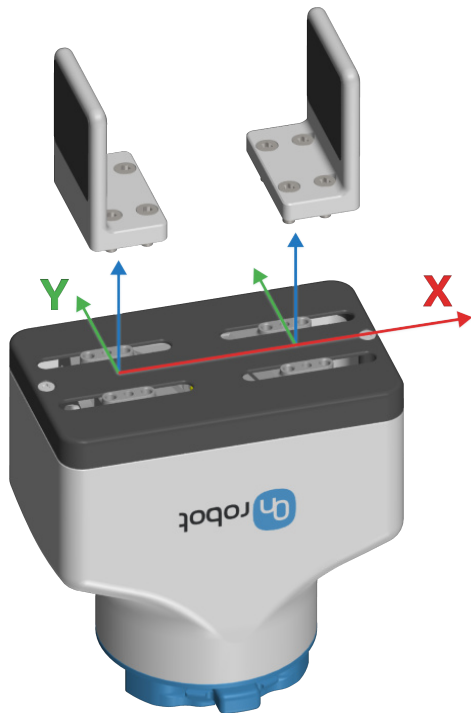

### Force vs Distance from finger platform

The graph below shows how the maximum allowable force decreases as the distance from the finger platform increases in case of customized fingers. The graph is valid for all types of individual distances shown in the image below.

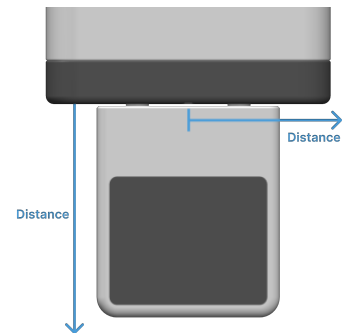
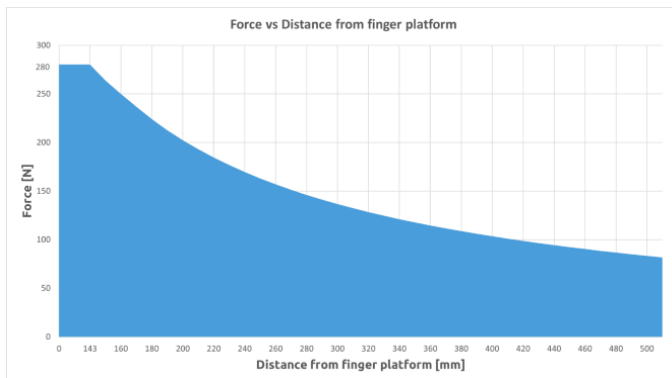

### Types of Grips

In this document, we use the internal and external grip terms, which indicates how the tool grips the workpiece.

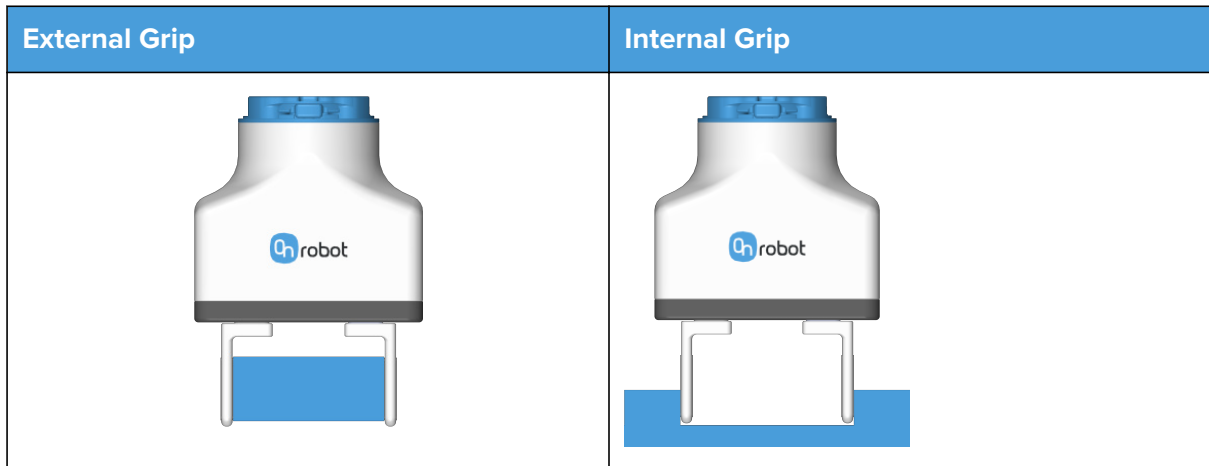

**Current Requirements**

Robot Type	Maximum Current
ABB	2000 mA
FANUC CRX	2000 mA
Kassow	700 mA
UR	600 mA

## 1.2. 2FG14

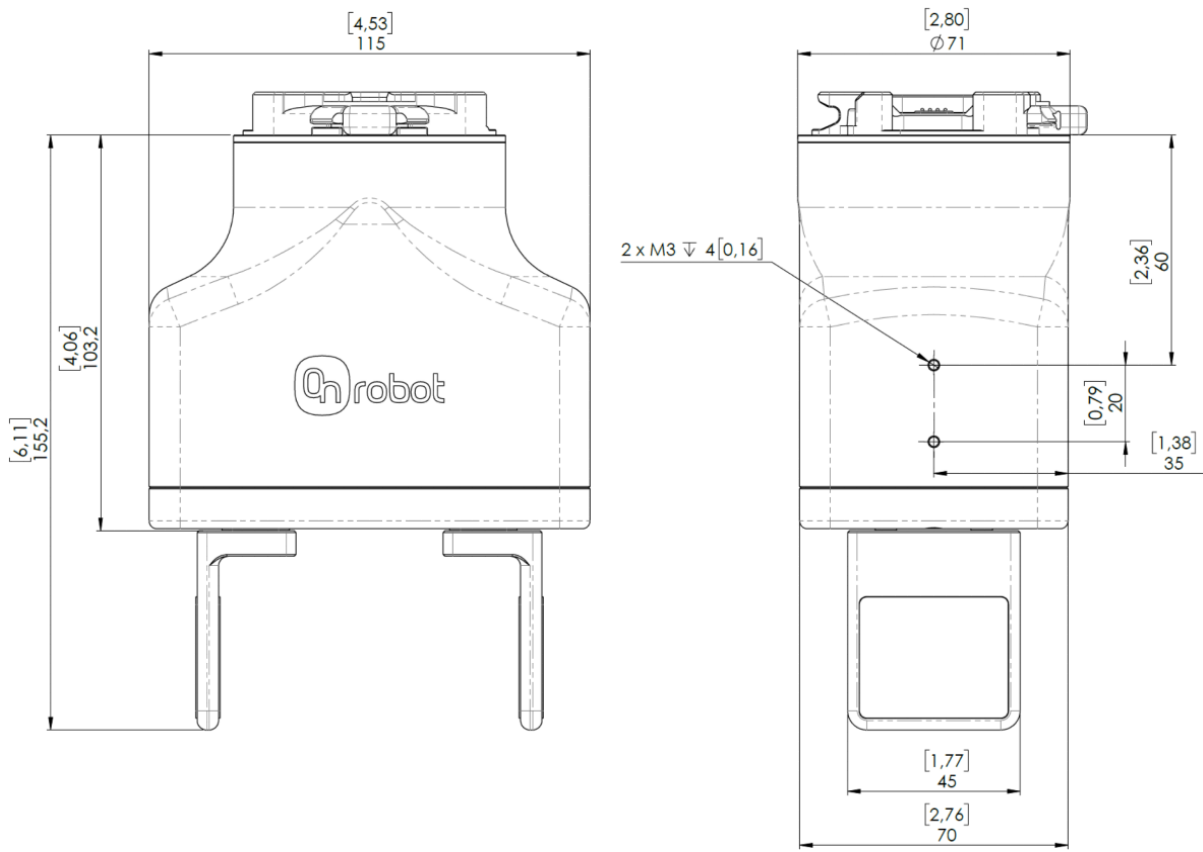

All dimensions are in mm and [inches].