

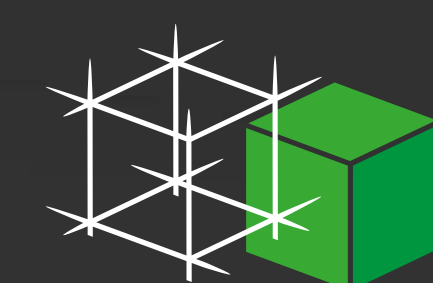

Better Life with Robots
Powered by JAEGER-ENGINEERING

xmate | New-Generation
Flexible Collaborative Robot

A Partner You can Rely on in Production



JAEGER ENGINEERING

+49-7725-494999-3

www.jaeger-engineering.de

info@jaeger-engineering.de

Product Vision

New-Generation Flexible Collaborative Robot

The global labor shortage has created increasing demands for robots in industrial production. As robots are adopted in more and more applications, they are required to be safer, more flexible, and easier to use. The introduction of collaborative robots paves the way for human-robot collaboration, but their application faces huge challenges in many scenarios, such as high-precision assembly in industrial production, compliant human-robot interaction in wellness physiotherapy, and high-precision operations in medical surgery, to name just a few. To satisfy these new scenarios, new robot technologies are needed.

ROKAE's new-generation flexible collaborative robots come with intelligent force sensing and vision. This allows the original open-loop teaching-execution process to be replaced with an intelligent closed-loop process that features dynamic interaction with the environment, making possible safe and accurate interaction between the environment and people. The disruptive innovation enables the robots to unlock more scenarios and become a partner you can rely on in production.

xmate

A Powerful Yet Flexible All-Rounder

PRODUCT CHARACTERISTICS



Extreme Safety

- Sensitivity improved by 10 times thanks to the collision detection by torque sensors
- > 20 adjustable safety features, up to ISO 13849-1, Cat.3, PL d safety certification
- Dual-channel redundant monitoring of sensor information and an independently certified safety controller
- Position holding accuracy of ± 0.1 mm powered by suction contracting brake and dynamic feedforward compensation

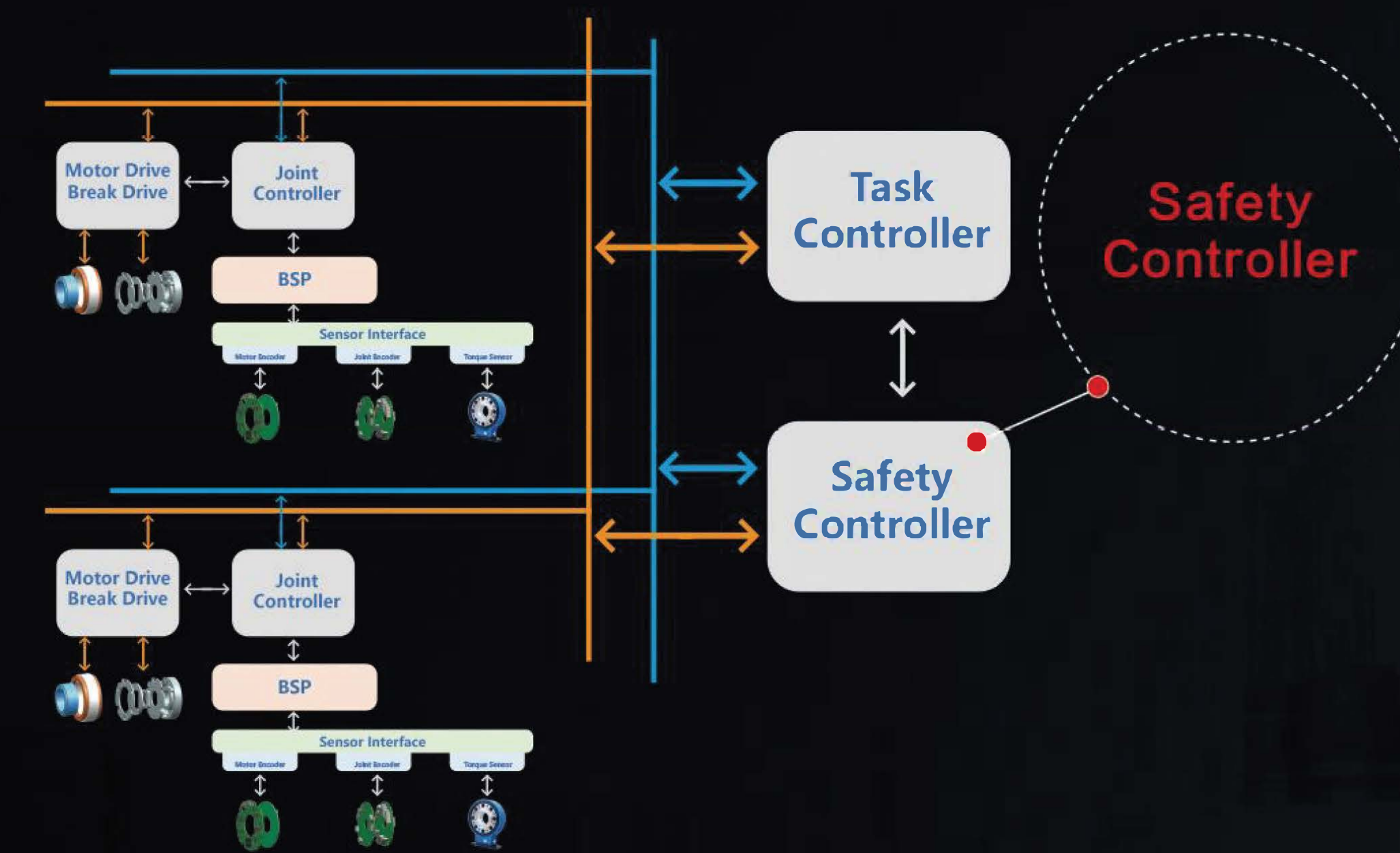

Safety Architecture



one-touch stop

Superior Performance

- Cutting-edge motion control technologies for industrial robots: OptiMotion, TrueMotion, and SyncMotion
- First-class robot path accuracy supported by dynamic feedforward compensation and dynamic modeling based on over 100 parameters
- Payload capacity increased by 20% thanks to the customized motor drive control system

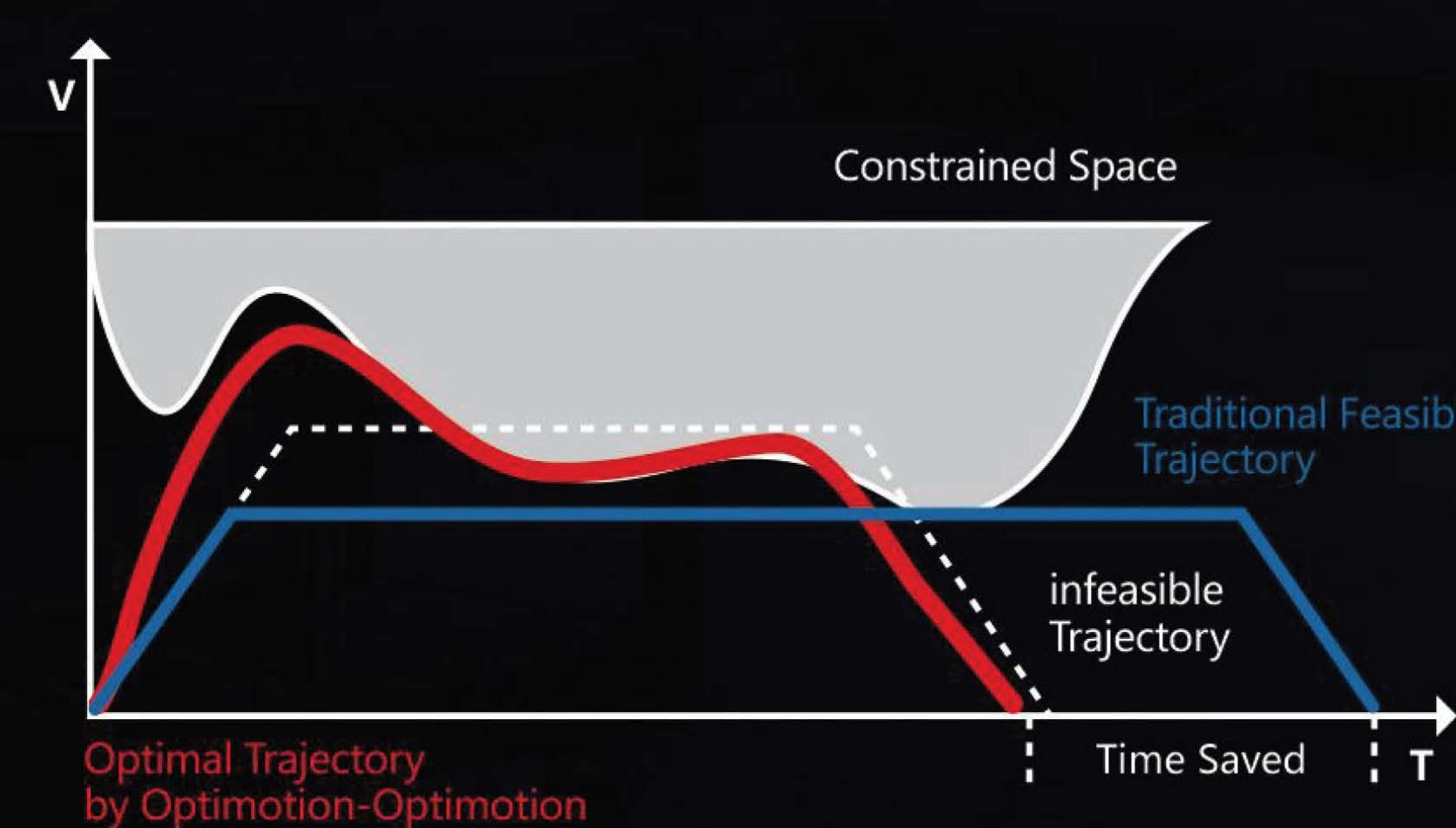

Optimal Takt Time

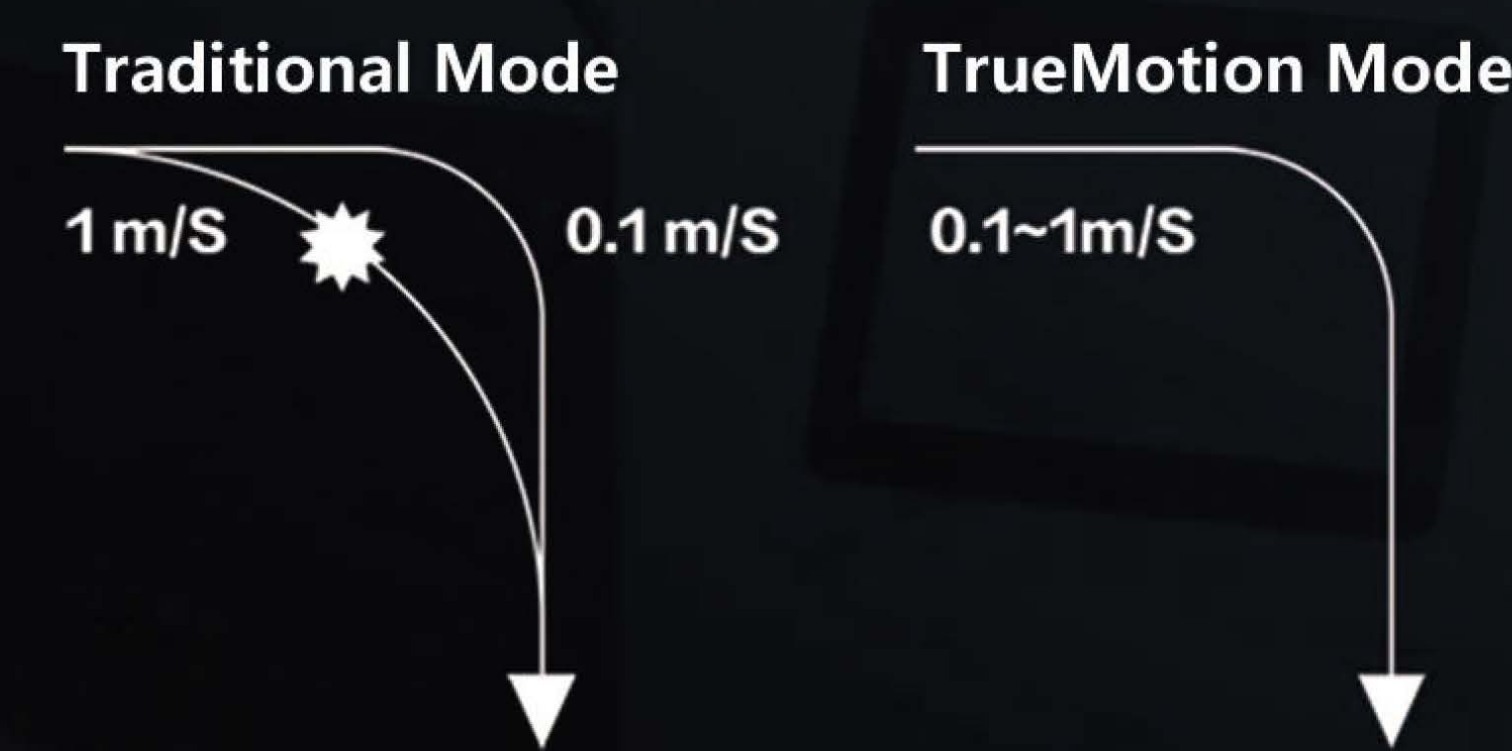

Accurate Trajectory

Compliant Flexibility

- Powerful yet flexible robot control based on patented unified force-position hybrid control framework
- Force control task efficiency improved by over 3 times through highly dynamic force control
- Fine grinding and precision assembly with no extension required thanks to built-in joint sensors and complete force control process kit

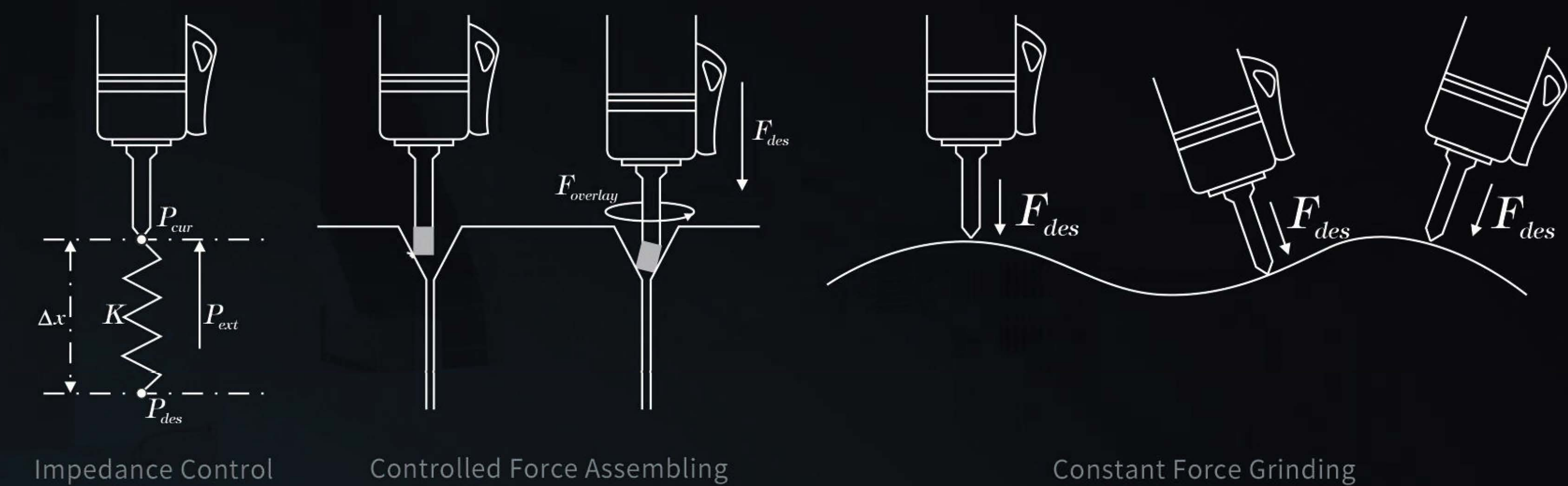

Ease of Use

- Cabinet-free design reduces system weight by 50% and allows for fast installation and flexible deployment
- Direct teaching control with 1N based on point position and continuous trajectory
- Graphical programming interface with flowcharts enables users to get started within 1 hour
- Friendly development and open ecosystem support 100+ ecosystem extension tools of 5 categories

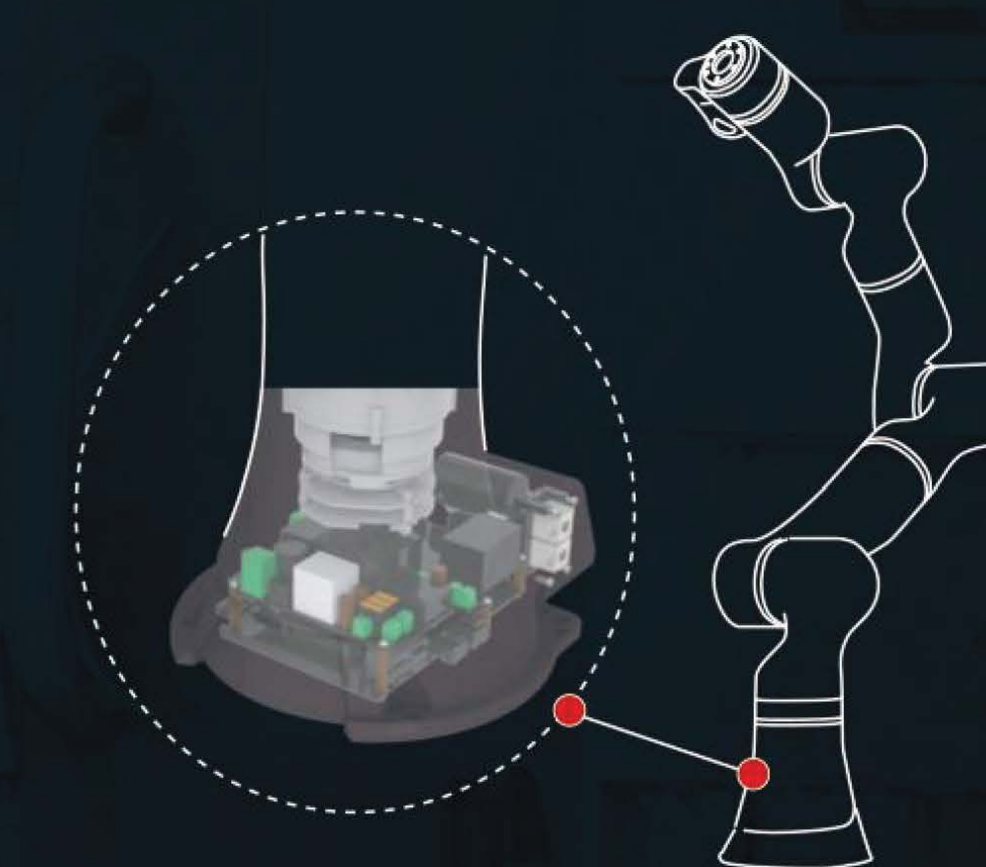

Cabinet-free Design



Graphical Programming

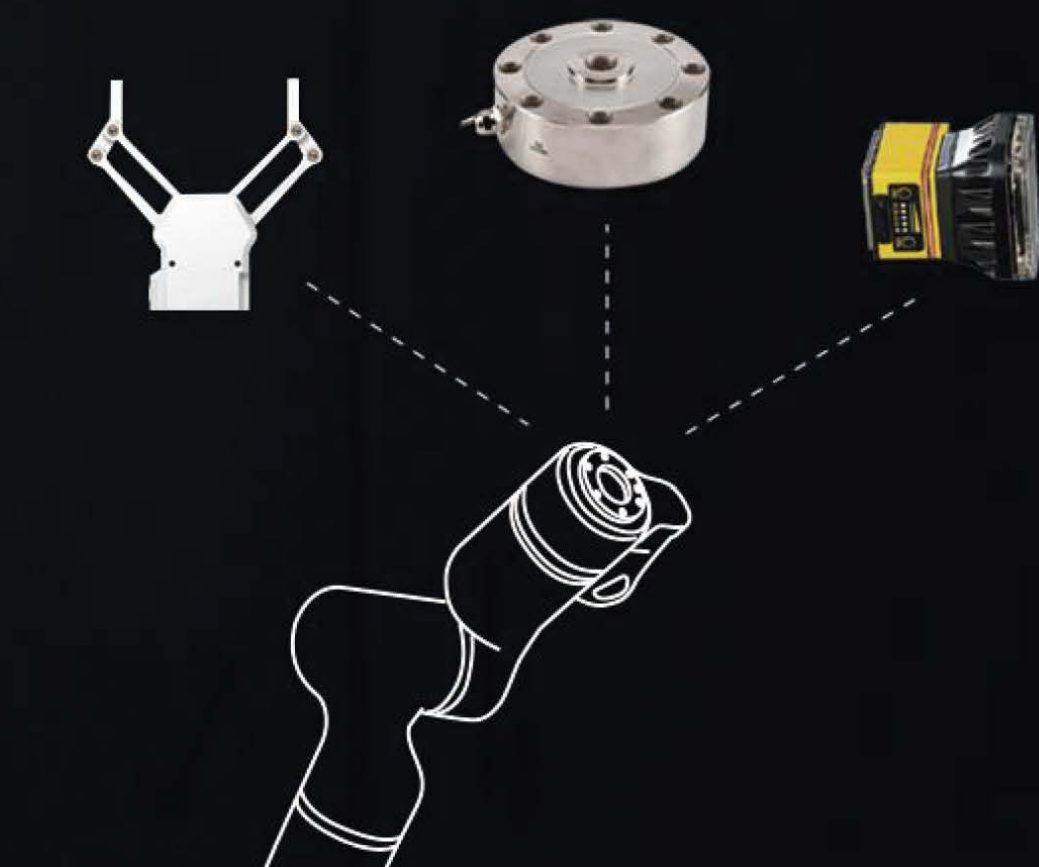

Open Ecosystem

Excellent Reliability

- Motion planning based on dynamics constraints delivers high performance, overload protection, and an extended service life
- 100+ design verification experiments, 20+ factory tests, and MTBF > 50,000 h
- IP67 protection level satisfies the demands of harsh industrial applications



Better Protection

PRODUCT SERIES

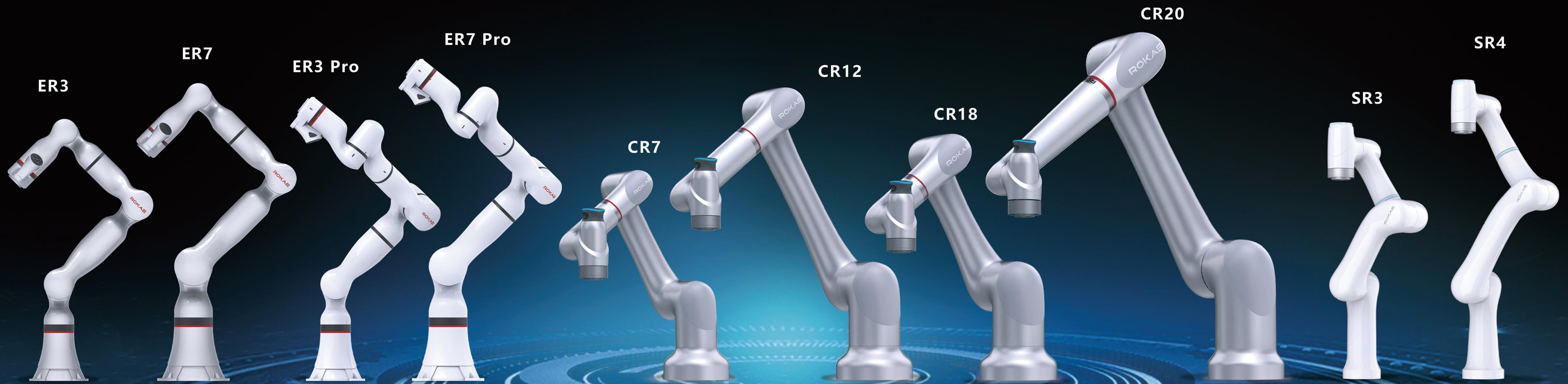

SR

Flexible Collaborative Robots

xMate SR, ROKAE's next-generation flexible cobot series that is lightweight, flexible, and great in cost performance, is a good helper for people's work and life.

- The cobot features industrial-grade high-performance core components that ensure stable and reliable around-the-clock operations.
- Each joint is equipped with a torque sensor that enables high-precision one-touch stop collision detection. Together with multiple protections such as independent safety control and 20 safety features, human-machine safety collaboration is brought into full play.
- Only 1N for dragging and direct teaching programming enables easy adjustment of point positions with one hand. With graphical programming, extensive secondary development interfaces, and cabinet-free design, robot operations are much easier for all users.



Model **SR4**
Payload **4kg**
Reach **919mm**



Model **SR3**
Payload **3kg**
Reach **705mm**

CR Flexible Collaborative Robots

xMate CR series flexible collaborative robots are built on the force-position hybrid control framework and xCore, a new self-developed high-performance control system for industrial robots. Designed for industrial applications, the robots deliver improved motion performance, force control, safety, ease of use, and reliability.

The CR series includes the **CR7**, **CR12**, **CR18** and **CR20**, with different payload capacities and working ranges. Highly dynamic force control integrated into the joints increases the payload by 20% compared with competitors. Besides, the CR series is lighter, easier to use, safer, more precise, and more reliable. This makes it an ideal choice for different applications in various industries, helping enterprises implement flexible production quickly.

- Modern ergonomic design for comfortable grip
- Large multi-touch high-definition LCD supporting zoom, swipe, and tap
- Hot-swapping, wired communication, and sharing between robots
- As light as 840g for easy teach programming
- Intuitive UI layout allowing quick start within 10 minutes



xPad2

CR

Model **CR7**
Payload **7kg**
Reach **988mm**



CR

Model **CR12**
Payload **12kg**
Reach **1,434mm**



CR

Model **CR20**
Payload **20kg**
Reach **1,798mm**



CR

Model **CR18**
Payload **18kg**
Reach **1,062mm**



ER

Flexible Collaborative Robots

The **xMate ER** series flexible collaborative robots feature torque sensors for all joints. Powered by direct force control with full state feedback, they excel in obstacle avoidance and collision detection, and ensure high precision of position control without sacrificing the highly dynamic force control and compliance control function.

The ER series is available in four models: **ER3, ER7, ER3 Pro, and ER7 Pro**, and two versions: six and seven degrees of freedom.

Practical direct teaching control and RL programming language provide users with a simpler and more comprehensive programming experience. Open RCI low-level control satisfies the requirements of high-end users in such fields as education, research, and automatic process development. The ER series is now pushing the limits of applications in various industries.



Model **ER7**
Payload **7kg**
Reach **1,125mm**



Model **ER3**
Payload **3kg**
Reach **1,010mm**



Model **ER3 Pro**
Payload **3kg**
Reach **1,010mm**



Model **ER7 Pro**
Payload **7kg**
Reach **1,125mm**

SR3

SR4

Specifications

Payload	3 kg	4 kg
Reach	705 mm	919 mm
Weight	About 13.8 kg	About 16.5 kg
Degrees of freedom	6 revolute joints	6 revolute joints
MTBF	> 50,000 h	> 50,000 h
Power supply	48VDC	48VDC
Programming	Direct teaching control and graphical interface	Direct teaching control and graphical interface

Performance

Power consumption	Average	Peak	Average	Peak
	160w	500w		

Safety Over 20 adjustable safety features including collision detection, virtual walls, and collaboration mode.

Certification EN ISO 13849-1, Cat.3, PL d, EN ISO 10218-1, and EU CE marking requirements

Force sensing (tool flange)	Force, x-y-z	Torque, x-y-z	Force, x-y-z	Torque, x-y-z
Force measurement resolution	0.1 N	0.02 Nm	0.1 N	0.02 Nm
Relative accuracy of force control	0.5 N	0.1 Nm	0.5 N	0.1 Nm
Adjustable range of Cartesian stiffness	0~3,000 N/m, 0~300 Nm/rad		0~3,000 N/m, 0~300 Nm/rad	
Operating temperature	0°C~45°C		0°C~45°C	
Humidity	≤ 95% RH (non-condensing)		≤ 95% RH (non-condensing)	

Motion

Repeatability	±0.03 mm		±0.05 mm	
Motion joint	Working range	Maximum speed	Working range	Maximum speed
Axis 1	±175°	180°/s	±175°	180°/s
Axis 2	-155°~+140°	180°/s	-160°~+150°	180°/s
Axis 3	-175°~+135°	180°/s	-170°~+140°	180°/s
Axis 4	±175°	225°/s	±175°	225°/s
Axis 5	±175°	225°/s	±175°	225°/s
Axis 6	±175°	225°/s	±175°	225°/s
Maximum speed at tool end	≤ 1.5 m/s		≤ 2 m/s	

Features

IP rating	IP54
ISO cleanroom class	5
Noise	≤ 70 dB(A)
Robot installation	At any angle
Tool I/O ports	2 Digital outputs, 2 Digital inputs, 2 Analog inputs
Tool communication interface	One 100-megabit Ethernet port with RJ45 interface on the connection base
Tool I/O power supply	(1) 12V/24V 1A (2) 5V 1.5A
Controller common I/O ports	4 Digital outputs, 4 Digital inputs
Controller communication interface	2 channels Ethernet
Controller output power supply	24V, 1.5A

SR Series Specifications

Control System

Controller	Independent control box (LightCab)
Dimensions	228.5 mm×180 mm×88 mm
Operator interface	Notebook/PAD/xPad/Interactive Button
Safety protection device	1 external emergency stop
Direct teaching control	Drag mode: Cartesian space/joint space; teaching mode: point position/continuous trajectory
Highly dynamic force control	Impedance control of Cartesian/joint space; motion planning for force control search
Communication protocols	TCP/IP 1000Mbit, Modbus TCP, Profinet, Ethernet/IP, DeviceNet, CC-Link, CC-Link IE Field Basic
External control interface	Highly dynamic external control; low-level force/position control; robot model library and API



SR3

SR4

CR7

CR12

CR18

CR20

Specifications

Payload	7 kg	12 kg	18 kg	20 kg
Reach	988 mm	1,434mm	1,062mm	1,798mm
Weight	About 27 kg	About 43 kg	About 40 kg	About 75 kg
Degrees of freedom	6 revolute joints	6 revolute joints	6 revolute joints	6 revolute joints
MTBF	> 50,000 h	> 50,000 h	> 50,000 h	> 50,000 h
Power supply	90-264VAC, 47-63Hz/48VDC	90-264VAC, 47-63Hz/48VDC	90-264VAC, 47-63Hz/48VDC	90-264VAC, 47-63Hz/48VDC
Programming	Direct teaching control and graphical interface	Direct teaching control and graphical interface	Direct teaching control and graphical interface	Direct teaching control and graphical interface

Performance

Power consumption	Average	Peak	Average	Peak	Average	Peak	Average	Peak
	500 w	1,500 w	600 w	2,000 w	600 w	2,000 w	1,000 w	3,000 w

Safety	Over 20 adjustable safety features including collision detection, virtual walls, and collaboration mode.							
Certification	EN ISO 13849-1, Cat.3, PL d, EN ISO 10218-1, and EU CE marking requirements							
Force sensing (tool flange)	Force, x-y-z	Torque, x-y-z	Force, x-y-z	Torque, x-y-z	Force, x-y-z	Torque, x-y-z	Force, x-y-z	Torque, x-y-z
Force measurement resolution	0.1 N	0.02 Nm	0.1 N	0.02 Nm	0.1 N	0.02 Nm	0.1 N	0.02 Nm
Relative accuracy of force control	0.5 N	0.1 Nm	0.5 N	0.1 Nm	0.5 N	0.1 Nm	0.5 N	0.1 Nm
Adjustable range of Cartesian stiffness	0~3,000 N/m, 0~300 Nm/rad		0~3,000 N/m, 0~300 Nm/rad		0~3,000 N/m, 0~300 Nm/rad		0~3,000 N/m, 0~300 Nm/rad	
Operating temperature	0°C~45°C		0°C~45°C		0°C~45°C		0°C~45°C	
Humidity	≤ 93% RH (non-condensing)		≤ 93% RH (non-condensing)		≤ 93% RH (non-condensing)		≤ 93% RH (non-condensing)	

Motion

Repeatability	±0.03 mm		±0.03 mm		±0.03 mm		±0.05 mm	
Motion joint	Working range	Maximum speed	Working range	Maximum speed	Working range	Maximum speed	Working range	Maximum speed
Axis 1	±175°	180°/s	±175°	120°/s	±175°	120°/s	±175°	120°/s
Axis 2	±175°	180°/s	±170°	120°/s	±170°	120°/s	±175°	120°/s
Axis 3	±175°	234°/s	±175°	180°/s	±165°	180°/s	±170°	120°/s
Axis 4	±175°	240°/s	±175°	234°/s	±175°	234°/s	±175°	234°/s
Axis 5	±175°	240°/s	±175°	240°/s	±175°	240°/s	±175°	234°/s
Axis 6	±175°	300°/s	±175°	240°/s	±175°	240°/s	±175°	234°/s
Axis 7	—	—	—	—	—	—	—	—
Maximum speed at tool end	≤ 3.2 m/s		≤ 3 m/s		≤ 3 m/s		≤ 3.5 m/s	

Features

IP rating	IP54/IP67
ISO cleanroom class	5
Noise	≤ 70 dB(A)
Robot installation	At any angle
Tool I/O ports	2 Digital outputs, 2 Digital inputs, 2 Analog inputs
Tool communication interface	RS485
Tool I/O power supply	12V/24V 1A
Pedestal common I/O ports	4 Digital outputs, 4 Digital inputs, 4 safety I/O
Pedestal communication interface	1 channels Ethernet
Pedestal output power supply	24V, 1.5A

CR Series Specifications

Control System

Controller	Built-in controller
Operator interface	Notebook/PAD/xPad/Interactive Panel
Safety protection device	1 handheld enable / 1 handheld emergency stop
Direct teaching control	Drag mode: Cartesian space/joint space; teaching mode: point position/continuous trajectory
Highly dynamic force control	Impedance control of Cartesian/joint space; motion planning for force control search
Communication protocols	TCP/IP 1000Mbit, Modbus TCP, Profinet, Ethernet/IP, DeviceNet, CC-Link, CC-Link IE Field Basic
External control interface	Highly dynamic external control; low-level force/position control; robot model library and API

xPad2

Dimensions	290 mm×190 mm×80 mm
Weight	840 g
Cable length	5 m/7 m/15 m/22 m
Display	10.1-in LCD with a resolution of 1920×1200
IP rating	IP54

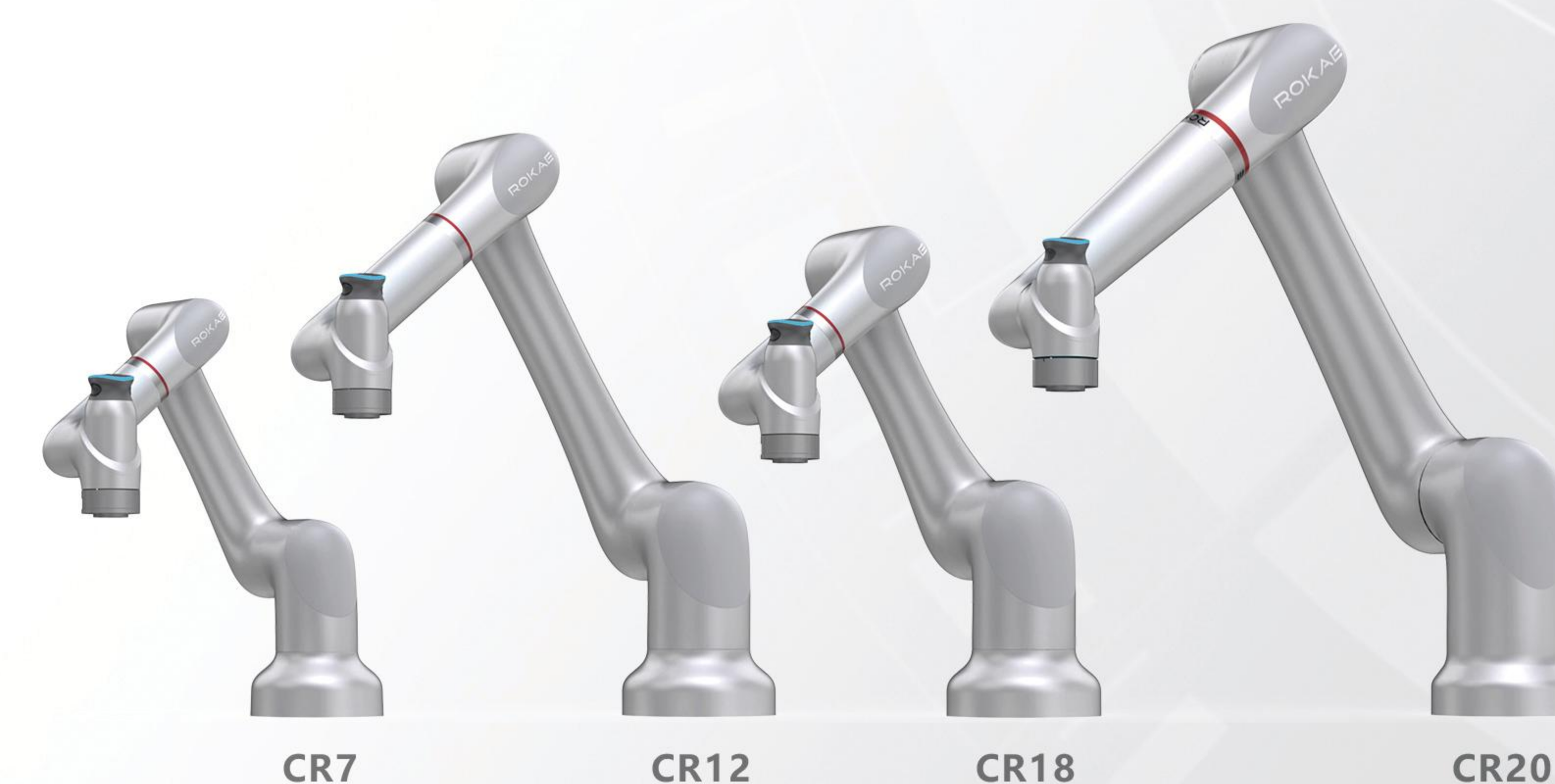

ER3

ER7

ER3 Pro

ER7 Pro

Specifications

Payload	3 kg	7 kg	3 kg	7 kg
Reach	1,010 mm	1,125 mm	1,010 mm	1,125 mm
Weight	About 21 kg	About 27 kg	About 22 kg	About 29 kg
Degrees of freedom	6 revolute joints	6 revolute joints	7 revolute joints	7 revolute joints
MTBF	> 50,000 h	> 50,000 h	> 50,000 h	> 50,000 h
Power supply	90-264VAC, 47-63Hz/48VDC	90-264VAC, 47-63Hz/48VDC	90-264VAC, 47-63Hz/48VDC	90-264VAC, 47-63Hz/48VDC
Programming	Direct teaching control and graphical interface	Direct teaching control and graphical interface	Direct teaching control and graphical interface	Direct teaching control and graphical interface

Performance

Power consumption	Average	Peak	Average	Peak	Average	Peak	Average	Peak
	200 w	400 w	500 w	900 w	300 w	500 w	600 w	1,000 w

Safety Over 20 adjustable safety features including collision detection, virtual walls, and collaboration mode.

Certification EN ISO 13849-1, Cat.3, PL d, EN ISO 10218-1, and EU CE marking requirements

Force sensing (tool flange)	Force, x-y-z	Torque, x-y-z	Force, x-y-z	Torque, x-y-z	Force, x-y-z	Torque, x-y-z	Force, x-y-z	Torque, x-y-z
Force measurement resolution	0.1 N	0.02 Nm	0.1 N	0.02 Nm	0.1 N	0.02 Nm	0.1 N	0.02 Nm
Relative accuracy of force control	0.5 N	0.1 Nm	0.5 N	0.1 Nm	0.5 N	0.1 Nm	0.5 N	0.1 Nm
Adjustable range of Cartesian stiffness	0~3,000 N/m, 0~300 Nm/rad		0~3,000 N/m, 0~300 Nm/rad		0~3,000 N/m, 0~300 Nm/rad		0~3,000 N/m, 0~300 Nm/rad	
Operating temperature	0°C~45°C		0°C~45°C		0°C~45°C		0°C~45°C	
Humidity	≤ 90% RH (non-condensing)		≤ 90% RH (non-condensing)		≤ 90% RH (non-condensing)		≤ 90% RH (non-condensing)	

Motion

Repeatability	±0.03 mm		±0.03 mm		±0.03 mm		±0.03 mm	
Motion joint	Working range	Maximum speed	Working range	Maximum speed	Working range	Maximum speed	Working range	Maximum speed
Axis 1	±170°	180°/s	±170°	90°/s	±170°	180°/s	±170°	90°/s
Axis 2	±120°	150°/s	±120°	90°/s	±120°	150°/s	±120°	90°/s
Axis 3	±120°	180°/s	±120°	180°/s	±170°	180°/s	±170°	120°/s
Axis 4	±170°	225°/s	±170°	180°/s	±120°	180°/s	±120°	120°/s
Axis 5	±120°	225°/s	±120°	180°/s	±170°	225°/s	±170°	120°/s
Axis 6	±360°	225°/s	±360°	180°/s	±120°	225°/s	±120°	120°/s
Axis 7	—	—	—	—	±360°	225°/s	±360°	120°/s
Maximum speed at tool end	≤ 3 m/s		≤ 2.8 m/s		≤ 3 m/s		≤ 2.5 m/s	

Features

IP rating	IP54
ISO cleanroom class	5
Noise	≤ 70 dB(A)
Robot installation	At any angle
Tool I/O ports	2 Digital outputs, 2 Digital inputs
Tool communication interface	RS485
Tool I/O power supply	24V 1A
Pedestal common I/O ports	4 Digital outputs, 4 Digital inputs, 4 safety I/O
Pedestal communication interface	2 channels Ethernet
Pedestal output power supply	24V, 1.5A

ER Series Specifications

Control System

Controller	Built-in controller
Operator interface	Notebook/PAD/Interactive Panel
Safety protection device	1 handheld enable / 1 handheld emergency stop
Direct teaching control	Drag mode: Cartesian space/joint space; teaching mode: point position/continuous trajectory
Highly dynamic force control	Impedance control of Cartesian/joint space; motion planning for force control search
Communication protocols	TCP/IP 1000Mbit, Modbus TCP, Profinet, Ethernet/IP, DeviceNet, CC-Link, CC-Link IE Field Basic
External control interface	Highly dynamic external control; low-level force/position control; robot model library and API



xMate Flexible Collaborative Robots
How do they change your industry?



Industry Applications

xMate flexible collaborative robots have found wide applications in automotive & parts, 3C and semiconductor, metal and plastic processing, research and education, business services, medical and other industries. They have played an important role in improving productivity and quality, enabling flexible production, and enhancing personnel safety.



xMate Flexible Collaborative Robots
Typical Applications

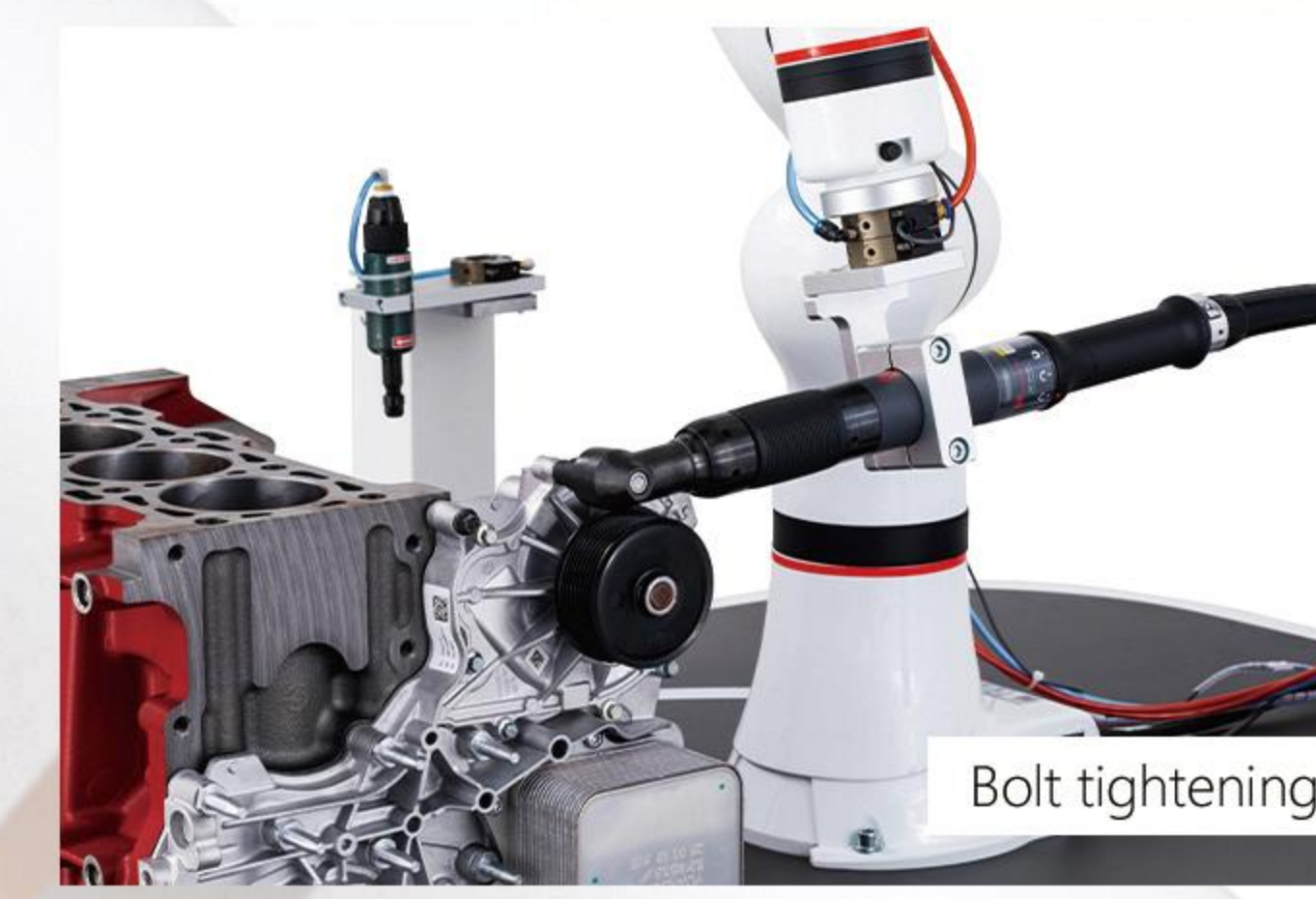
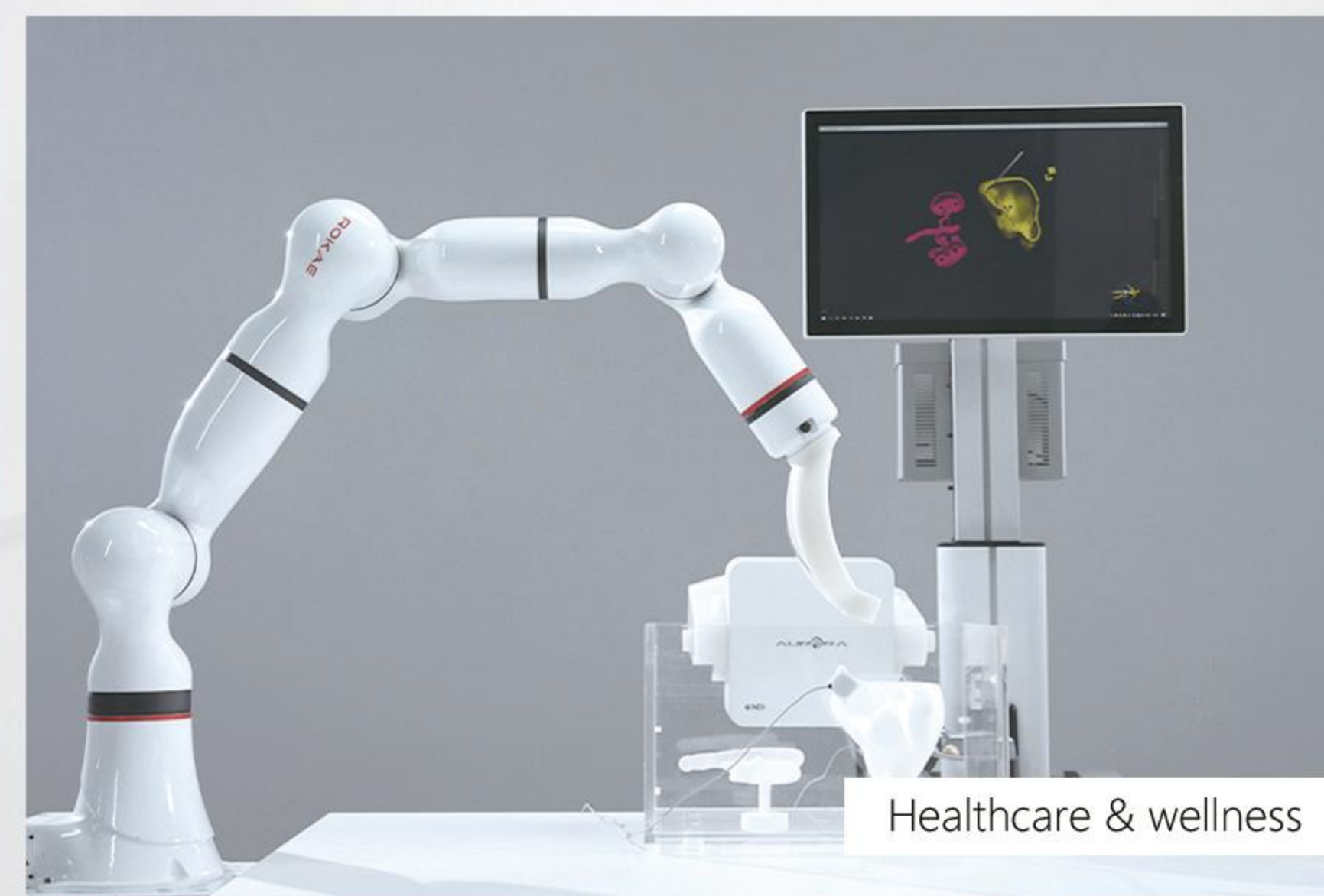

Typical application

xMate flexible collaborative robots can undertake a variety of tasks, including **compliant assembly, screw locking, inspection and measurement, handling, material removal, gluing, and equipment care**, driving improved productivity and flexible automation for companies of all sizes.

Automotive & Parts

While the automotive and parts industry enjoys a high level of automation, its supply chain still has lots of room for growth.

For example, the general assembly process is complex with flexible working procedures. Safer and more flexible collaborative robots can take the place of traditional industrial robots to cope with these complex processes and working conditions. They can add value at different stages of automotive manufacturing and boost overall productivity.



The automotive industry has rigorous standards and sophisticated systems, with quality and consistency in repetitive tasks being the top priority for customers. This makes cost-effective collaborative robots an ideal choice.

xMate flexible collaborative robots feature easy installation and secondary deployment, and satisfy the automotive industry's needs for customization and rapid response to changing markets. The best-in-class safety ensures operation safety without sacrificing efficiency, making human-robot coexistence and collaboration a reality.

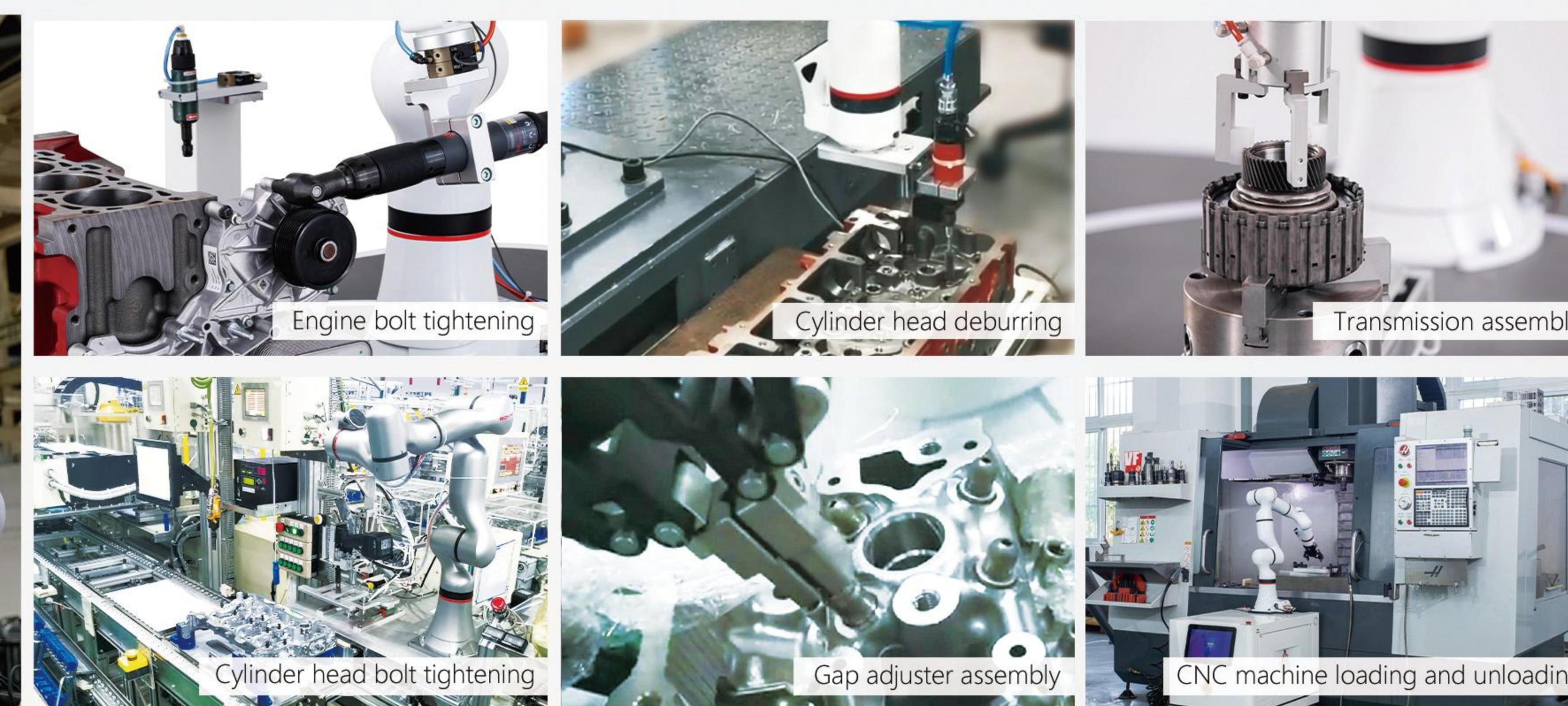
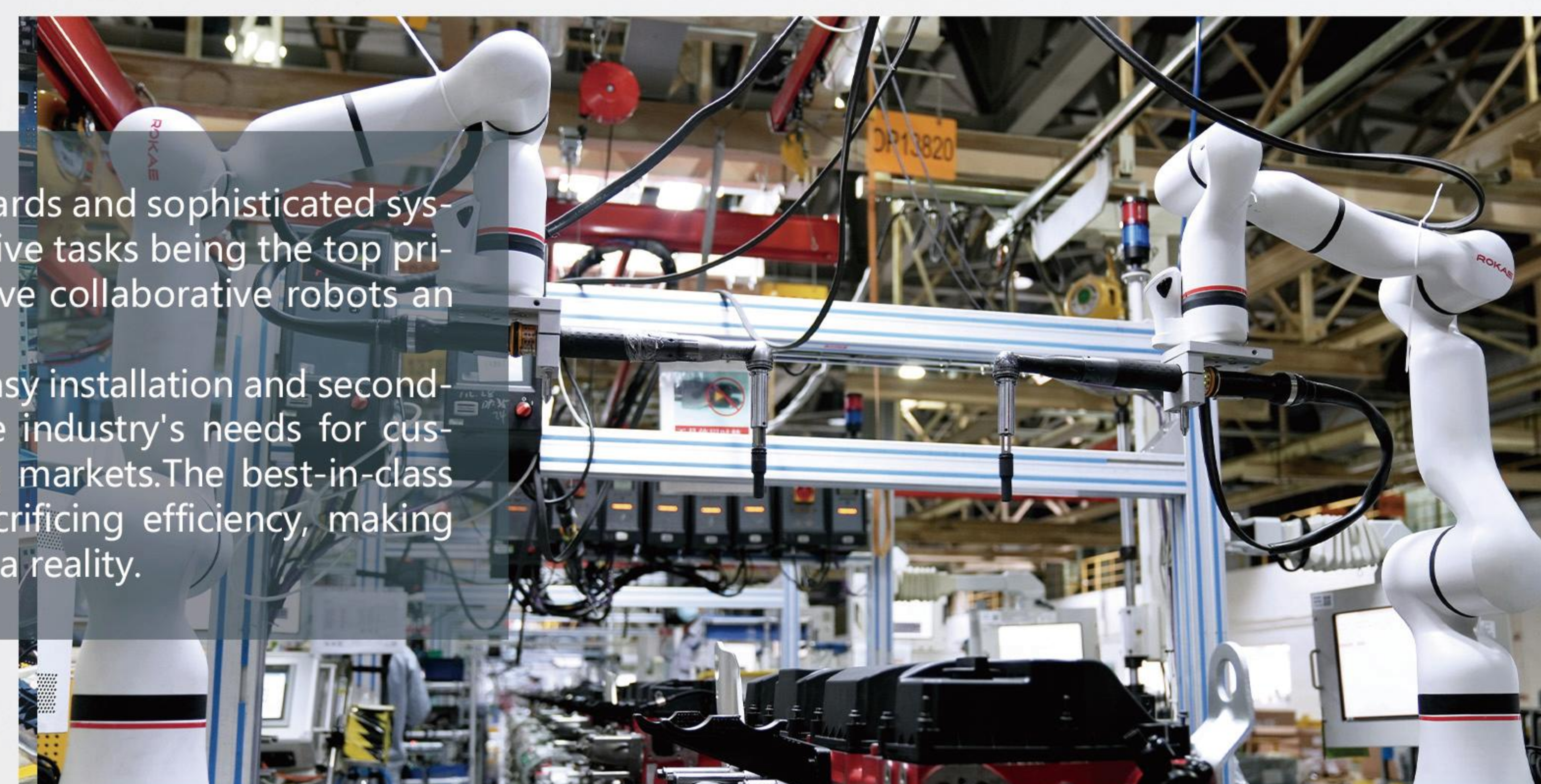

Advantages

Values for Customers

Ease of Use	Cabinet-free design, small footprint, and plug-and-play mechanical and electrical connectors mean easy and quick installation, which usually takes less than 10 minutes.
Extreme Safety	Ultrasensitive collision detection by torque sensors means no safety fence or grating is required.
Easy Programming	1N easy dragging and graphical programming interface allow users without programming experience to get started within an hour.
Compliant Force Control	Integrated joint force sensors eliminate the need for additional sensors, while the complete force control process kit greatly reduces the application extension cost.
Excellent Reliability	IP67 protection, 100+ design verification experiments, 20+ factory test items, and MTBF > 50,000 h.
Leading Performance	Cutting-edge motion control technologies enable the robot to perform repetitive tasks accurately and reliably. Product quality and consistency are enhanced as well.

Applications

Description

Bolt tightening at any angle	Equipped with a tightening gun, the robot tightens bolts at any angle and provides real-time visibility into the force/torque value.
Compliant Assembly	Space compliance allows the robot to assemble complex parts and prevent workpiece loss.
Deburring	Normal tracking and constant force control improve the quality and consistency of surface and edge deburring.
Loading and Unloading	Stable and flexible operation in tight spaces with no safety barriers required, making the robot ideal for tasks like loading and unloading spark plugs.
Gluing	Precise control over the gluing position and volume, e.g., on vehicle door frames and
Handling	End effectors ensure stable and flexible handling of workpieces in limited spaces, such as when loading and unloading vehicle dashboards.

3C and Semiconductor

The 3C (Computer, Communication, and Consumer Electronics) industry has gradually shifted from large-scale, mass production of standard products to customization and flexible manufacturing. The change in production mode has posed new requirements and challenges to automated production. As 3C products are diverse and the installation of traditional automation equipment is complex, it is difficult for the production line to adapt to new products, resulting in high secondary deployment costs. This makes rapid changeover nearly impossible.



In the fast-growing 3C industry, agility is the key for an enterprise to survive and succeed. Flexible collaborative robots can perform complex, dangerous, and highly repetitive tasks in a reliable and consistent way that human workers cannot, and enable them to focus on value-added tasks. Besides, the use of collaborative robots on production lines allows for easy and fast changeover, which translates to higher productivity.



Advantages

Values for Customers

Ease of Use	Cabinet-free design reduces the weight by 50% and enables fast cable change and redeployment, without affecting the production line.
Extreme Safety	Over 20 certified adjustable safety features ensure the highest safety when the robot is working next to workers.
Easy Programming	Practical direct teaching control, graphical programming interface with flowcharts, and one-touch project import and export allow for fast change-over.
Leading Performance	Cutting-edge motion control technologies enable the robot to perform repetitive tasks accurately and continuously. Product quality and consistency are enhanced as well.
Excellent Reliability	IP67 protection, compact structure, maintenance-free design, and MTBF > 50,000 h.
Compliant Force Control	Integrated joint sensors eliminate the need for additional sensors, while the complete force control process kit greatly reduces the application extension cost.

Applications

Description

Gluing and Dispensing	Precise control over the dispensing volume delivers improved appearance and reduced consumption, e.g. for PCB dispensing.
AGV	The robot can be used with a mobile trolley to meet the safety requirements in open spaces. Cabinet-free design and low power consumption make the trolley last longer in a single run.
Testing	Space compliance allows the robot to deal with inconsistent incoming parts and eliminate the internal force, such as in the connector plugging test.
Inspection	Visual inspection system works with highly dynamic force control to quickly identify defective and faulty parts, enabling non-destructive inspection such as screen inspection.
Screw Locking	The automatic screw locking machine allows the robot to complete both 2D and 3D locking tasks and repeat the same action with the same precision and speed.
Compliant Assembly	The robot accurately performs complex, compliant assembly tasks in tight spaces and prevents workpiece loss.

Education & Research

Robots, as key players in the manufacturing industry, have experienced rapid growth in recent years. However, further growth has been restricted due to the talent gap of over 10 million. Given the promising market and the soaring demand, cultivating more robotics talents is imperative.

For universities and academic institutions, it is important to conduct prospective studies on robotics, which requires robots to excel in intelligence, technology, and software platforms.



The new-generation xMate offers world-class flexible collaborative robots. Its safety, ease of use, and practicality can help colleges and universities pick up pace in cultivating robotics professionals to satisfy the soaring demands in the industry. With the development of robotics education and training, more hands-on practices and job opportunities will be created for students.



Advantages

Values for Customers

Ease of Use	Cabinet-free lightweight design allows plug-and-play in small labs and on classroom desks.
Extreme Safety	Ultrasensitive force sensing and over 20 certified safety features ensure the safety of human-machine collaboration.
Easy Programming	Direct teaching control with 1N (based on point position and continuous trajectory) makes operation much easier for all users.
Compliant Force Control	Complete force control process kit provides such modes as normal tracking, constant force control, and force control search, greatly enriching the practical training.
SDK for Secondary Development	Open low-level force control interface and 1 kHz real-time control frequency make secondary application development and expansion easier than ever.
Redundant Motion Control	7 degrees of freedom enables the robot to reach the same end-effector position with different configurations while null-Space Motion helps to avoid obstacles.
ROS Support	ROS interface makes the robot even more versatile and allows for ROS teaching.

Applications

Description

Robot Algorithm Verification	Kinematics, dynamics, force control, and motion planning function libraries can be used to verify new robot algorithms.
Visual Servo Control	Images obtained by the camera can be fed into the closed loop of position feedback and enable visual servo control.
Teleoperation Control	Force sensing capability enables manual guidance, assisted teleoperation, and gravity compensation for remote control.
Adaptive Control	Sensitive force sensing can be used to identify and respond to external forces based on the user-programmed system performance.
Teaching and Training	Differentiated features such as seven-axis design and compliant force control help integrators enrich and expand the course contents.
Robot Competition	Skill training can be combined with technical competitions to promote the application of robots in intelligent manufacturing.

Healthcare

As the medical industry starts to recognize the benefits of using robots at different stages of diagnosis and treatment, medical robots, in particular surgical robots, see a broad market. In traditional surgeries, doctors have to hold surgical tools and stay focused for a long time. That has now changed with the advance of surgical robots. The robots, which can operate more flexibly and precisely with a better vision, not only free doctors' hands and relieve pressure on the limited medical resources, but also contribute to the operation effect by reducing trauma and bleeding.



xMate flexible collaborative robots come with integrated cabinet-free design, world-leading safety performance, and compliance control close to human arms. They are helping to push the limits of what is medically possible, benefit patients with more accurate, effective, and safe healthcare solutions, and improve the lives of those involved in the medical industry.

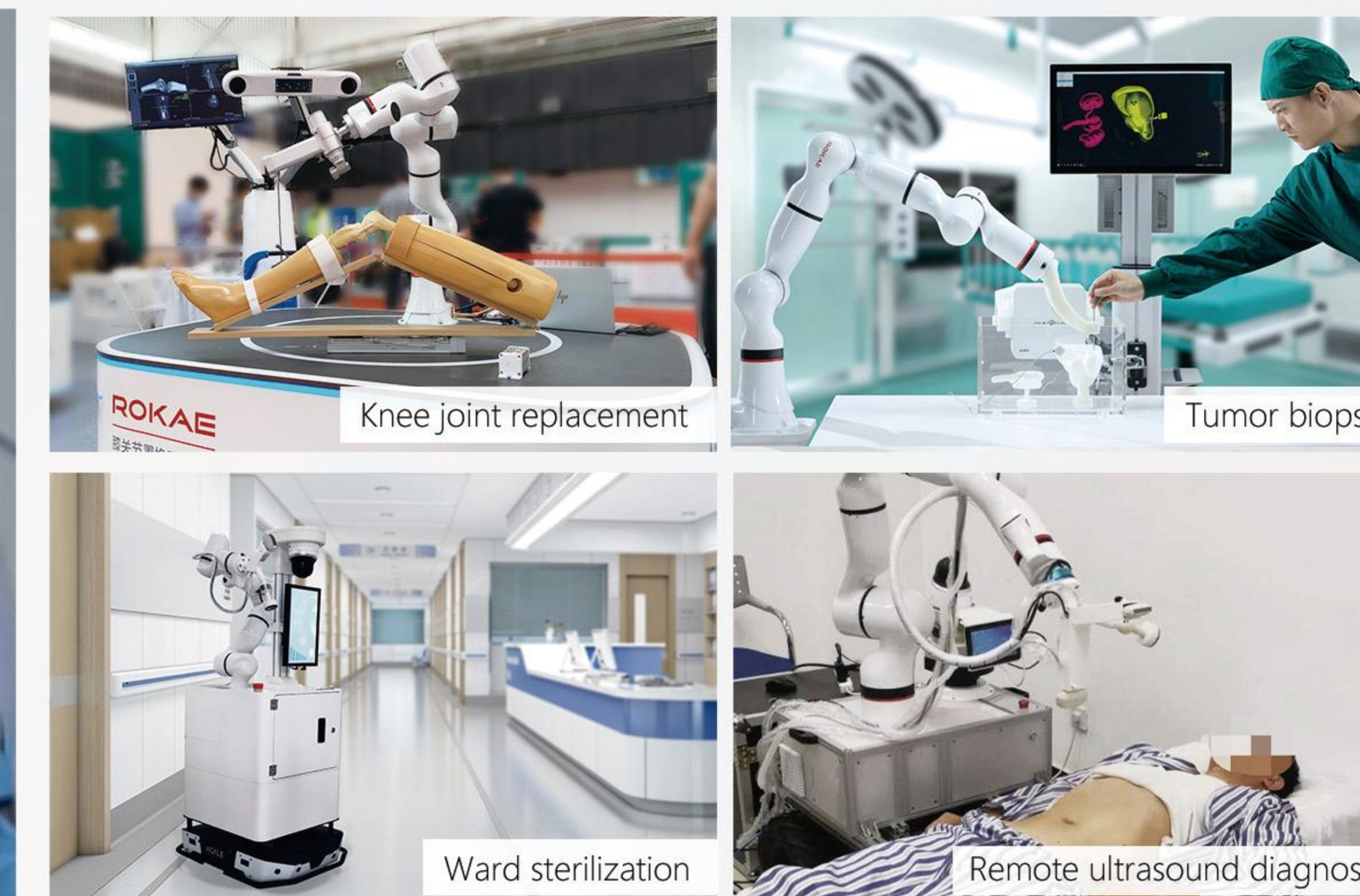

Advantages

Values for Customers

Redundant Motion Control	7 degrees of freedom provides the same flexibility as human arms, allowing for excellent obstacle avoidance without compromising the normal performance.
Extreme Safety	Suction contracting brake is combined with dynamic feedforward compensation to deliver a position holding accuracy of ± 0.1 mm and ensure safe surgeries.
Easy Programming	Practical direct teaching control, intelligent interactive panel at the wrist, and graphical programming interface make operation much easier for all users.
SDK for Secondary Development	Open low-level force control interface and 1 kHz real-time control frequency make secondary application development and expansion easier than ever.
Compliant Force Control	Integrated joint force sensors offer highly dynamic and sensitive force control, ensuring safe and intelligent interaction with the environment.
Open Ecosystem	The flexible wrist interface can be used with appropriate tools and programs for integration into medical equipment.

Applications

Description

Ultrasound Diagnosis	Reliable remote operation interaction through high-precision motion following and dynamic force feedback in real-time.
Orthopedic Surgery	Free from spatial interference during equipment and personnel operation thanks to flexible arrangement of manipulator position based on precise assisted positioning.
Minimally Invasive Surgery	Consistent doctor-robot movement ensured by an advanced motion mode that simulates human wrist movement and eliminates the impact of hand tremors.
Laparoscopic Surgery	Precise operation powered by the highly reliable real-time control system while taking laparoscope movement into account.
Neurosurgery	Frameless stereotactic surgery that is minimally invasive, precise, and efficient in 30 minutes on average.
Sterilization	Unattended sterilization in office buildings, lobbies, and other public places with quick deployment on a mobile trolley.

Commercial Services

Labor costs have been rising in recent years, so has consumer demand, which shows a trend of personalization and diversification. New consumer and retail applications such as unmanned supermarkets and vending machines are dominating the market. Health management businesses like intelligent cosmetic medicine and wellness physiotherapy are also gaining in popularity. Commercial services have become more intelligent than ever before.



Lightweight and intelligent collaborative robots that can take care of complex tasks are widely seen in commercial scenarios. xMate flexible collaborative robots feature world-class safety performance and compliance control close to human arms. Being easy-to-use, they can perform a variety of customized services, creating unlimited possibilities for the commercial service industry.



Advantages

Values for Customers

Ease of Use	Cabinet-free design and plug-and-play mechanical and electrical connectors mean quick installation within 10 minutes.
Lightweight & Flexible	Fashionable design and superb human-machine interaction.
Extreme Safety	Ultrasensitive collision detection by torque sensors makes one-touch stop possible and eliminates the need for a safety fence or grating.
Easy Programming	Direct teaching control with 1N, together with a graphical programming interface with flowcharts, makes operation much easier for all users.
Open Ecosystem	A wide selection of IO and communication interfaces support the majority of accessories in the industrial ecosystem, greatly expanding the scope of application.
Excellent Reliability	100+ design verification experiments, 20+ factory tests, and MTBF > 50,000 h.

Applications

Description

Rehabilitation	When used with rehabilitation equipment, the robot can assist patients in rehabilitation exercises with its highly dynamic force control.
Massage	3D vision and automatic trajectory generation enable the robot to generate personalized massage programs with multi-level adjustable force.
Moxibustion	The compliance control function of the robot works with artificial intelligence to make moxibustion safe, precise, and even.
Cosmetic Medicine	3D vision and artificial intelligence allow the robot to recognize and pinpoint tiny facial features.
Coffee Making	High positioning repeatability means that the robot can accurately reproduce Archimedes curve, spiral pouring, and other hand brewing coffee actions. It ensures consistent quality in a cost-effective manner.
Chef	Based on preset programs, the robot can precisely imitate the actions of a chef and complete cooking easily with one touch.