



KR 6 R900-2



Technical data

Maximum reach	901 mm
Maximum payload	6.7 kg
Pose repeatability (ISO 9283)	± 0.02 mm
Number of axes	6
Mounting position	Floor; Ceiling; Wall;
	Desired angle
Footprint	208 mm x 208 mm
Weight	approx. 55 kg

Axis data

Motion range	
A1	±170 °
A2	-190 ° / 45 °
A3	-120 ° / 156 °
A4	±185 °
A5	±120 °
A6	±350 °

Operating conditions

Ambient temperature during operation	0 °C to 45 °C (273 K to 318 K)
--------------------------------------	--------------------------------

Protection rating

Protection rating (IEC 60529)	IP65 / IP67
Protection rating, robot wrist (IEC 60529)	IP65 / IP67

Controller

Controller	KR C5 micro; KR C4 smallsize-2; KR C4 compact
------------	---

Certificates

ESD requirements	IEC61340-5-1; ANSI/ESD S20.20
------------------	-------------------------------

Cycle time

150 cycles per minute (25 mm / 305 mm / 25 mm, 1 kg)



Workspace graphic

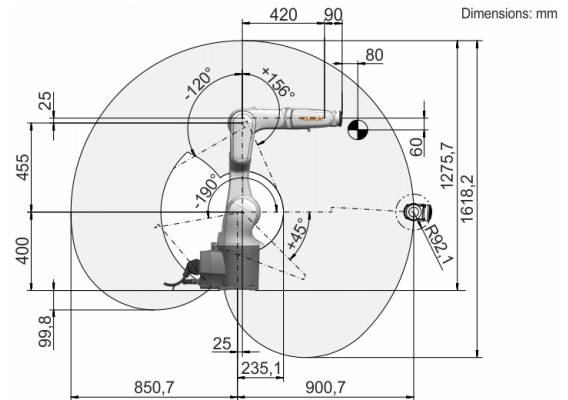

Payload diagram

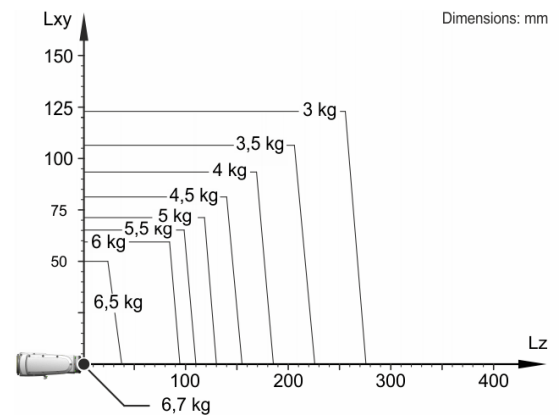

The KR 6 R900-2 is designed for a rated payload of 3 kg in order to optimize the dynamic performance of the robot. With reduced load center distances and favorable supplementary loads, a maximum payload of up to 6.7 kg can be mounted. The specific KUKA Load case must be verified using KUKA. For further consultation, please contact KUKA Service.

Mounting flange

